

Waveforms and spectra for a total-power radio telescope

IOR1, Graham Woan 2020

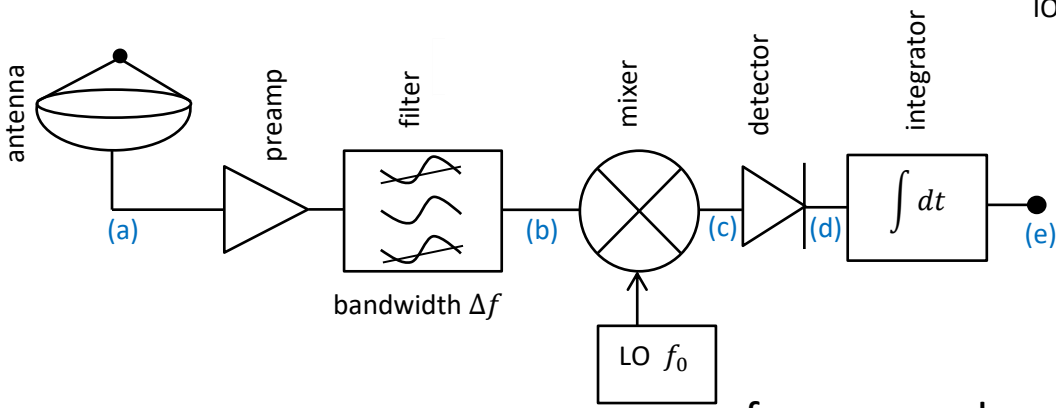

time domain (red V , blue V^2)

frequency domain (power spectra in dB)

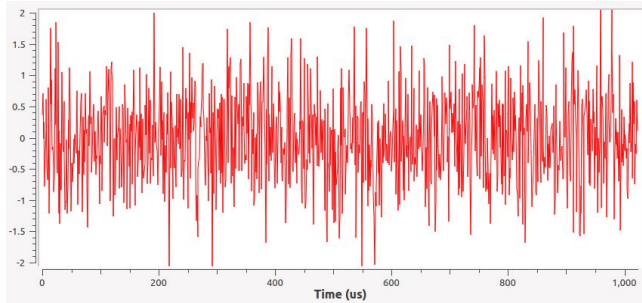

radio noise

(a)

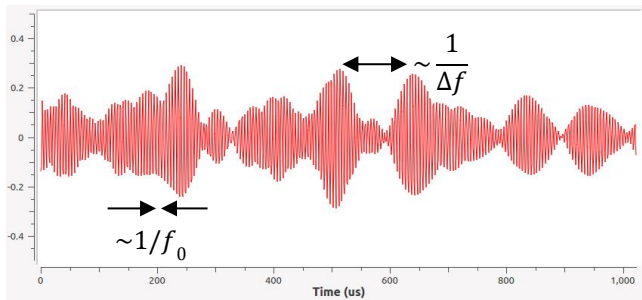
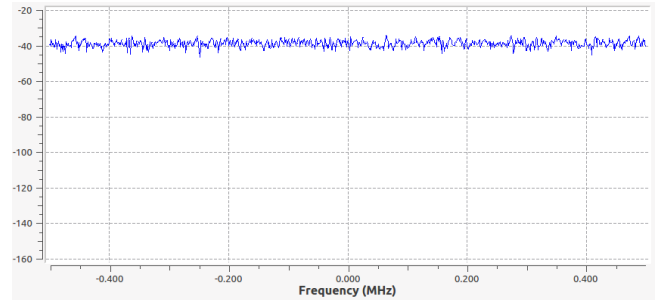

filtered noise

(b)

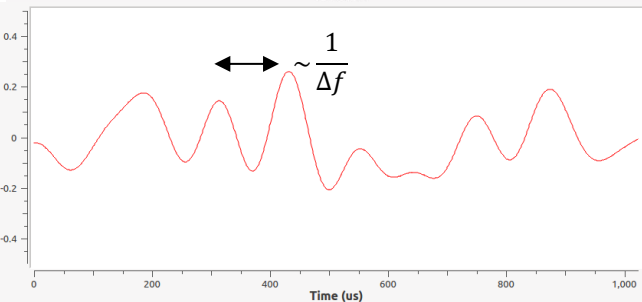
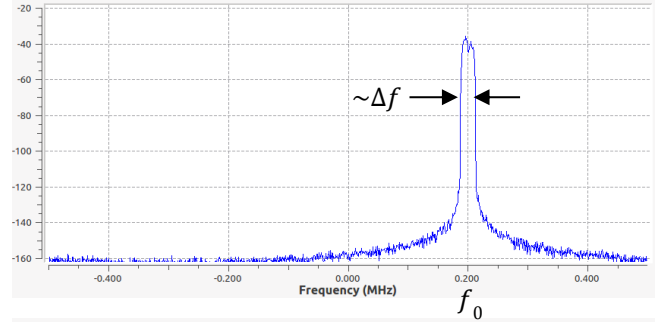

shifted to 0 Hz by mixer

(c)

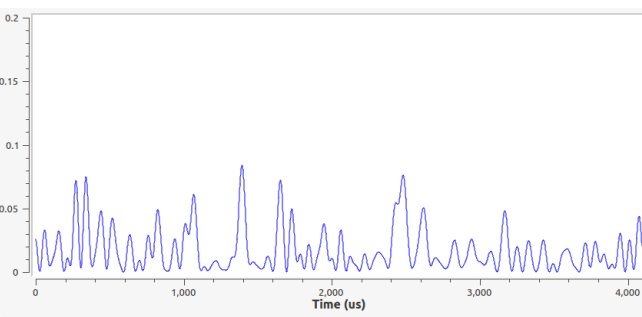
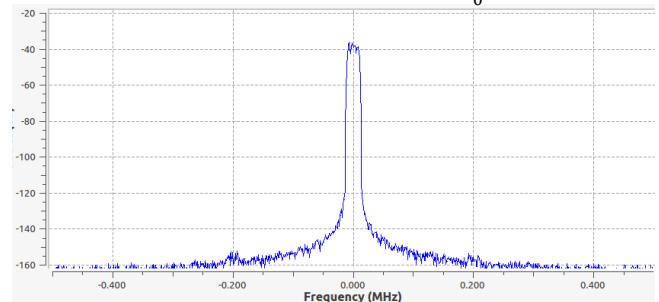

after the detector

(d)

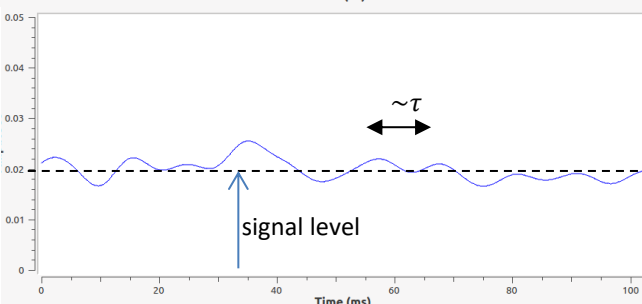
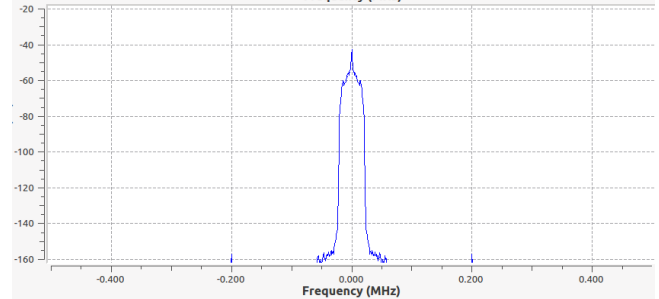

after the integrator

(e)

